

UE910 Family Product Description

80412ST10117A Rev.2 – 2013-09-12



APPLICABILITY TABLE

PRODUCT
UE910-EUR
UE910-EUD
UE910-NAR
UE910-NAD



Disclaimer

The information contained in this document is the proprietary information of Telit Communications S.p.A. and its affiliates ("TELIT").

The contents are confidential and any disclosure to persons other than the officers, employees, agents or subcontractors of the owner or licensee of this document, without the prior written consent of Telit, is strictly prohibited.

Telit makes every effort to ensure the quality of the information it makes available. Notwithstanding the foregoing, Telit does not make any warranty as to the information contained herein, and does not accept any liability for any injury, loss or damage of any kind incurred by use of or reliance upon the information.

Telit disclaims any and all responsibility for the application of the devices characterized in this document, and notes that the application of the device must comply with the safety standards of the applicable country, and where applicable, with the relevant wiring rules.

Telit reserves the right to make modifications, additions and deletions to this document due to typographical errors, inaccurate information, or improvements to programs and/or equipment at any time and without notice.

Such changes will, nevertheless be incorporated into new editions of this document.

Copyright: Transmittal, reproduction, dissemination and/or editing of this document as well as utilization of its contents and communication thereof to others without express authorization are prohibited. Offenders will be held liable for payment of damages. All rights are reserved.

Copyright © Telit Communications S.p.A. 2012.



Contents

1. Introduction	6
1.1. Scope.....	6
1.2. Audience	6
1.3. Contact Information, Support	6
1.4. Text Conventions	7
1.5. Related Documents	7
1.6. Document History.....	7
2. Overview.....	9
2.1. Product variants	10
2.2. Target Market.....	10
2.3. Features.....	10
2.4. Approvals.....	13
3. General Product Description.....	14
3.1. Dimensions and 2D mechanical drawing	14
3.2. Weight.....	15
3.3. Environmental requirements.....	15
3.3.1. Temperature range	15
3.3.2. RoHS compliance	15
3.4. Operating Frequency	16
3.5. Transmitter output power	17
3.6. Sensitivity	17
3.7. Antenna.....	18
3.7.1. Frequency band of GSM/WCDMA antenna	18
3.8. Supply voltage	18
3.9. Power consumption	19
3.10. Logic level	19
3.11. Input and Outputs	19
3.11.1. General Purpose I/Os	19
3.11.2. Power on monitor (PWR_MON).....	19



- 3.11.3. Power on/off control (ON_OFF)20
- 3.11.4. Auxiliary power output for accessory (VAUX)20
- 3.11.5. SIM Reader20
- 3.11.6. Converters20
- 3.11.7. Audio Interface20
- 3.11.8. Serial ports20
- 3.11.9. USB port.....20
- 3.11.10. User Interface20
- 3.12. Features 20**
 - 3.12.1. Speech Coding20
 - 3.12.2. SMS21
 - 3.12.3. RTC Bypass out.....21
 - 3.12.4. Data Transmission capabilities.....21
 - 3.12.5. Local security management.....21
 - 3.12.6. Call control21
 - 3.12.7. Phonebook21
 - 3.12.8. Characters management22
 - 3.12.9. SIM related functions22
 - 3.12.10. Call status indication22
 - 3.12.11. Automatic answer22
 - 3.12.12. Supplementary services22
- 3.13. Mounting the modules on your board 22**
- 3.14. Packing system 23**
- 4. Evaluation Kit 24**
- 5. AT Commands 25**
- 6. Safety Recommendations 26**
- 7. Conformity assessment issues 27**
 - 7.1. RTT&E Notified Body statement of Opinion 29**
 - 7.2. FCC certificates..... 30**
 - 7.3. IC certificates 32**
- 8. List of acronyms 33**



1. Introduction

1.1. Scope

Scope of this document is to give an overview of the Telit UE910 family, which can support GSM/GPRS/EDGE and WCDMA/HSPA with data/voice capabilities.

1.2. Audience

This document is intended for customers who are evaluating the UE910 family.

1.3. Contact Information, Support

For general contact, technical support, to report documentation errors and to order manuals, contact Telit Technical Support Center (TTSC) at:

TS-EMEA@telit.com
TS-NORTHAMERICA@telit.com
TS-LATINAMERICA@telit.com
TS-APAC@telit.com

Alternatively, use:

<http://www.telit.com/en/products/technical-support-center/contact.php>

For detailed information about where you can buy the Telit modules or for recommendations on accessories and components visit:

<http://www.telit.com>

To register for product news and announcements or for product questions contact Telit Technical Support Center (TTSC).

Our aim is to make this guide as helpful as possible. Keep us informed of your comments and suggestions for improvements.

Telit appreciates feedback from the users of our information.



1.4. Text Conventions



Danger – This information MUST be followed or catastrophic equipment failure or bodily injury may occur.



Caution or Warning – Alerts the user to important points about integrating the module, if these points are not followed, the module and end user equipment may fail or malfunction.



Tip or Information – Provides advice and suggestions that may be useful when integrating the module.

All dates are in ISO 8601 format, i.e. YYYY-MM-DD.

1.5. Related Documents

- UE910 family Hardware User Guide, 1VW0301012
- Telit Modules Software User Guide, 1VW0300784
- Telit IP Easy User Guide, 80000ST10028A
- HE Family Ports Arrangements, 1VW0300971
- HE910 Digital Voice Interface Application Note, 80000NT10050A
- SPI Port Application Note, 80000NT10053A
- SIM Holder Design Guides, 80000NT10001a
- Telit EVK2 User Guide, 1v0300704

1.6. Document History

Revision	Date	Changes
0	2012-09-17	First issue
1	2013-03-21	Updated product features
2	2013-09-12	Updated chapters 3.3, 3.9 Added certificates in chapter 7





2. Overview

The UE910 product family complete the offering of products based on HSPA technology. It includes low cost 3.5G modules, dual-band, designed on the xE910 LGA unified form factor. The UE910 offers “voice capable” variants, featuring both analog or digital audio, and data-only variants.

In addition to pin-to-pin compatibility, also the AT command interface is fully compatible with the companion HE910 module.

It features an internal codec that gives customers the choice between digital or analog voice. Moreover an embedded SIM-chip is also available as mounting option.

It is ideal for low cost application that do not require a global coverage and, due to the great variety of features within the xE910 family, it allows customers to tailor their choice according the specific needs of their application: design once and deploy globally.

As a part of Telit’s corporate policy of environmental protection, all Telit products comply with the RoHS (Restriction of Hazardous Substances) directive of the European Union (EU Directive 2011/65/EU)



NOTE:

Some of the performances of the Telit modules depend on S/W version installed on the module itself. The Telit modules S/W group is continuously working in order to add new features and improve the overall performances. The Telit modules are easily upgraded by the developer using the Telit Flash Programmer.



NOTE:

In order to meet the competitive OEM and vertical market stringent requirements, Telit supports its customers with a dedicated Support Policy with:

- Telit Evaluation Kit EVK2 to help you to develop your application;
 - A website with all updated information available;
 - An high level specialist technical support to assist you in your development;
-



2.1. Product variants

All UE910 variants are dual-band GSM/GPRS/EDGE and dual band UMTS/HSPA

Variant name	Upload	Download	Frequencies		Features	
	HSUPA (Mbps)	HSDPA (Mbps)	UMTS HSPA+ bands (MHz)	GSM GPRS EDGE bands (MHz)	Data	Voice
EMEA / APAC / Latin America markets						
UE910-EUR	5.76	7.2	900/2100	900/1800	■	■
UE910-EUD	5.76	7.2	900/2100	900/1800	■	
North America market						
UE910-NAR	5.76	7.2	850/1900	850/1900	■	■
UE910-NAD	5.76	7.2	850/1900	850/1900	■	

2.2. Target Market

The UE910 family is designed and developed for applications such as:

- Telemetry
- Telematics
- Security alarms
- AMR (automated meter reading)
- Low-cost 3G applications
- High-bandwidth applications
- Regional markets

2.3. Features

- Advanced E-GPRS/WCDMA/HSDPA/HSUPA Software protocol stack (Layer 1 to 3) – Version: 3GPP Release 7
- GSM Quad band (900/1800 MHz for EUx, 850/1900 MHz for NAX)
- WCDMA dual-band: B1&B8 for the EUx models and B2&B5 for the NAX models
- HSDPA up 7.2Mbps
- HSUPA up to 5.76Mbps
- WCDMA up to 384kbps downlink/uplink
- DTM (Dual Transfer Mode)



UE910 Family Product Description
80412ST10117A - Rev.2 – 2013-09-12

- CPC (DRX/DTX) (Continuous Packet Connectivity)
- DARP
- Control via AT commands according to 3GPP TS27.005, 27.007 and Telit customized AT commands
- Serial port multiplexer 3GPP TS27.010
- SIM application Tool Kits 3GPP TS 51.014
- Power consumption (typical values)
 - Stand-by current 2G, DRX5, 1.1 mA
 - Stand-by current 3G, DRX7, 1.2 mA
- Output power
 - Class 4 (2W) @ 850 / 900 MHz, GSM
 - Class 1 (1W) @ 1800 / 1900 MHz, GSM
 - Class E2 (0.5W) @ 850/900 MHz, EDGE
 - Class E2 (0.4W) @ 1800/1900 MHz, EDGE
 - Class 3 (0.25W) @ 850/900/1900/2100 MHz, WCDMA
- Sensitivity:
 - - 109 dBm (typ.) @ 850 / 900 MHz (GSM)
 - - 110 dBm (typ.) @ 1800 / 1900 MHz (GSM)
 - - 111 dBm (typ.) @ 850/900/1900 / 2100 MHz (WCDMA)

Interfaces

- 10 general I/O ports maximum including multi-functional I/Os
- I2S for digital audio interface
- Analog audio (balanced)
- USB 2.0 HS
- 1 UART
- 1 Auxiliary serial port (RX/TX only)
- SPI
- 1 I2C
- 1.8V/3V SIM interface



Audio

- Telephony, emergency call
- HR, FR, EFR, AMR for GSM and AMR for WCDMA voice codec
- Spatial Noise Suppression
- Multiple audio profiles pre-programmed and fully configurable
- DTMF

SMS

- Point to point mobile originated and mobile terminated SMS
- Concatenated SMS supported
- SMS cell broadcast
- Text and PDU mode
- SMS over GPRS

Data transmission

- HSPA: category 8 in downlink e category 6 in uplink
 - DL up to 7.2Mbps
 - UL up to 5.76Mbps
- WCDMA: up to 384kbps downlink/uplink
- Asynchronous non-transparent CSD up to 9.6kbps
- GPRS class 10 for NAX variants and class 33 for EUX variants
- EDGE class 10 for NAX variants and class 33 for EUX variants
- Coding scheme 1 to 4 (GPRS) & Modulation Coding scheme 1 to 9 (EDGE)

GSM Supplementary Services

- Call forwarding
- Call barring
- Call waiting & call hold
- Advice of charge
- Calling line identification presentation [CLIP]
- Calling line identification restriction [CLIR]



- Unstructured supplementary services mobile originated data [USSD]
- Closed user group

Additional features

- SIM phonebook
- Fixed Dialling Number (FDN)
- Call control & status indication
- SIM phonebook
- Character management (IRA, UCS2, GSM)
- USIM 3GPP Rel.7
- Real Time Clock
- Automatic answer
- Alarm management
- Embedded TCP/IP stack, including TCP, IP, UDP, and FTP protocols
- CSD for Video Telephony support

2.4. Approvals

- Fully type approved confirming with R&TTE directive
- CE, GCF
- FCC, IC, PTCRB,
- RoHS (all versions)



3. General Product Description

3.1. Dimensions and 2D mechanical drawing

UE910 has a Land-Grid-Array (LGA) package, with 144 pads.

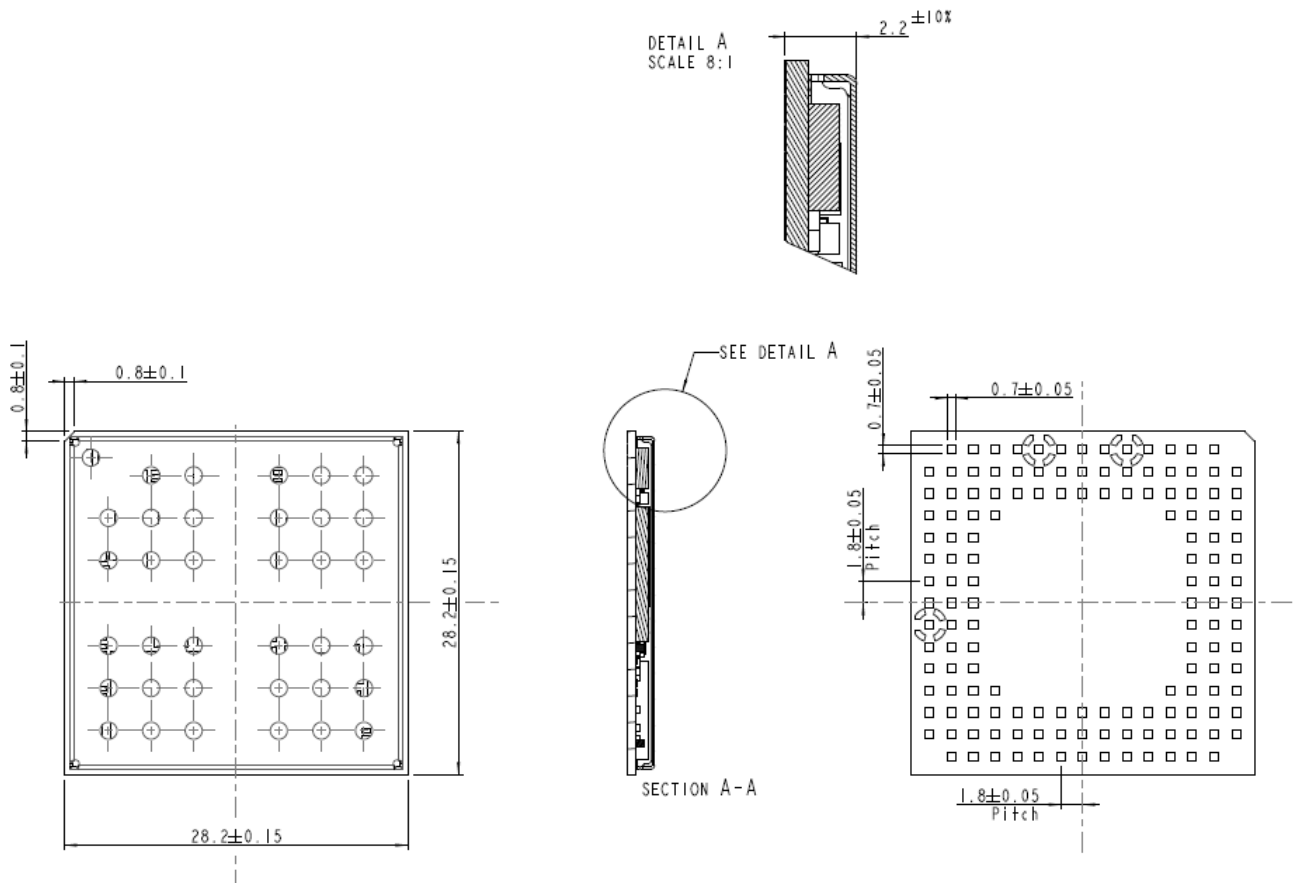

The overall dimensions of UE910 family are:

- Length: 28.2 mm
- Width: 28.2mm
- Thickness: 2.2 mm



3.7. Antenna

3.7.1. Frequency band of GSM/WCDMA antenna

The antenna that the customer chooses should fulfill the following requirements:

ANTENNA REQUIREMENTS	
Frequency range	Depending by frequency band(s) provided by the network operator, the customer shall use the most suitable antenna for that/those band(s)
Bandwidth (GSM/EDGE)	70 MHz in GSM850, 80 MHz in GSM900, 170 MHz in DCS & 140 MHz PCS band
Bandwidth (WCDMA)	70 MHz in WCDMA Band V 80 MHz in WCDMA Band VIII 140 MHz in WCDMA Band II 250 MHz in WCDMA Band I
Gain	1.4dBi @900 and 3dBi @1800 1.4dBi @850 and 3dBi @1900 1.43 dBi (WCDMA)
Impedance	50 ohm
Input power	> 33dBm(2 W) peak power in GSM > 24dBm Average power in WCDMA
VSWR absolute max	≤ 5:1 (limit to avoid permanent damage)
VSWR recommended	≤ 2:1 (limit to fulfil all regulatory requirements)

For further information, please refer to the UE910 family Hardware User Guide.

3.8. Supply voltage

The external power supply must be connected to VBATT signal and must fulfill the following requirements:

Nominal Supply Voltage	3.8V
Operating Voltage Range	3.4 ~ 4.2V
Extended Operating Voltage Range	3.1 ~ 4.5V



CAUTION:

The operating voltage **MUST** not be exceeded; Special care must be taken when designing the application's power supply section to avoid an excessive voltage drop. If the voltage drop is exceeding the limits it could cause a Power Off of the module.



3.9. Power consumption

The UE910 power consumptions are described in the following table

UE910		
Mode	Average (mA)	Mode description
SWITCHED OFF		
Switched Off	180 uA	Module supplied but Switched Off
IDLE mode (WCDMA)		
AT+CFUN=1	12.2	Normal mode: full functionality of the module
AT+CFUN=5	1.8	Full functionality with power saving; DRX7; Module registered on the network can receive incoming calls and SMS
IDLE mode (GSM/EDGE)		
AT+CFUN=1	19	Normal mode: full functionality of the module
AT+CFUN=4	16.5	Module is not registered on the network
AT+CFUN=5	1.2	Full functionality with power saving; DRX9 (1.3mA in case of DRX5).
Operative mode (WCDMA)		
WCDMA Voice	152	WCDMA voice call (TX = 10dBm)
WCDMA HSDPA (0dBm)	187	WCDMA data call (Cat 8, TX = 0dBm)
WCDMA HSDPA (22dBm)	494	WCDMA data call (Cat 8, TX = 22dBm)
Operative mode (EDGE)		
EDGE 4TX+1RX		
GSM 850/900 - G8	495	EDGE Sending data mode
DCS1800/ PCS1900 - G7	484	
Operative mode (GSM)		
CSD TX and RX mode		
GSM 850/900 CSD PL5	220	GSM VOICE CALL
DCS1800/ PCS1900 CSD PL0	167	
GPRS 4TX+1RX		
GSM 850/900 PL5	580	GPRS Sending data mode
DCS1800/ PCS1900 PL0	438	

Depending on network configuration and not under module control

3.10. Logic level

Where not specifically stated, the most of interface circuits work at 1.8V CMOS logic levels. To get more detailed information about the logic level specifications used for UE910 family, please refer to the UE910 family Hardware User Guide.

3.11. Input and Outputs

3.11.1. General Purpose I/Os

10 pins of general purpose I/Os can be configured by AT command in three different ways as input, output and alternative function.

3.11.2. Power on monitor (PWR_MON)

The PWR_MON indicates the status of the module running properly.



3.11.3. Power on/off control (ON_OFF)

External power on/off control input. Refer to the UE910 family Hardware User Guide for more details of Power on timing.

3.11.4. Auxiliary power output for accessory (VAUX)

A regulated 1.8V power output is provided for an external device.

3.11.5. SIM Reader

The UE910 family supports 1 SIM/USIM at 1.8V and 3V ONLY with and external SIM connector. For 5V SIM, an external level translator can be added. Refer to the UE910 family Hardware User Guide.

3.11.6. Converters

The UE910 family has 1 ADC and 1DAC.

3.11.7. Audio Interface

The UE910 Module is provided by an Analog Audio section.

A Digital Audio bus is available as well (not simultaneously with the analog one).

3.11.8. Serial ports

Two serial ports are available.

- Full RS232-C
- Auxiliary serial port (RX/TX only)

3.11.9. USB port

The USB2.0 High Speed has a clock rate of 480MHz

3.11.10. User Interface

The user interface is managed by AT commands according to ITU-T V.250, 3GPP 27.007 and 27.005 specifications. Please refer to the UE910 AT command User Guide for complete details.

3.12. Features

3.12.1. Speech Coding

The UE910 family support the following voice codecs:

- Adaptive Multi Rate for WCDMA



- Half Rate, Full Rate, Enhanced Full Rate, Adaptive Multi Rate for GSM

3.12.2. SMS

The UE910 family supports the following SMS types:

- Mobile Terminated (MT) class 0 ~ 3 with signaling of new incoming SMS, SIM full, SMS read
- Mobile Originated class (MO) 0 ~ 3 with writing, saving in SIM and sending
- Cell broadcast compatible with CB DRX signaling of new incoming SMS.

The UE910 supports also SMS over GPRS

3.12.3. RTC Bypass out

The VRTC pin brings out the Real Time Clock supply, which is separate from the rest of the digital part, allowing having only RTC going on when all the other parts of the device are off.

To this power output a backup capacitor can be added in order to increase the RTC autonomy during power off of the battery. NO Devices must be powered from this pin.

3.12.4. Data Transmission capabilities

The UE910 family supports:

- HSPA: D/L up to 7.2Mbps, U/L up to 5.76Mbps
- Asynchronous non-transparent CSD up to 9.6kbps for GSM, 14.4kbps for WCDMA
- EDGE Class 10 for NAX variants and Class 33 for EUx variants
- Coding scheme 1 to 4 (GPRS) & Modulation Coding scheme 1 to 9 (EDGE)

3.12.5. Local security management

The local security management can be done with the lock of Universal Subscriber Identity Module (USIM), and the security code will be requested at power-up.

3.12.6. Call control

The calling cost control function is supported.

3.12.7. Phonebook

This function allows storing the telephone numbers into SIM memory. The capability depends on the SIM version and its embedded memory.

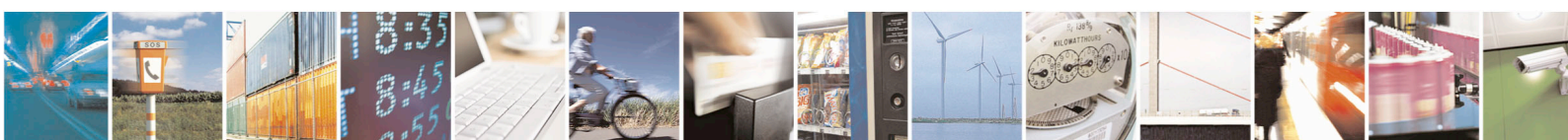

3.12.8. Characters management

The UE910 family supports the IRA, GSM, PCCP437, 8859-1 and UCS2 character sets, in TEXT and PDU mode.

3.12.9. SIM related functions

Activation and deactivation of the numbers stored in phone book FDN (Fixed Dialing Numbers), ADN (Abbreviated Dialing Number) and PIN insertion are supported. Extension at the PIN2 for the PUK2 insertion capability for lock condition is supported too.

3.12.10. Call status indication

The call status indication is supported.

3.12.11. Automatic answer

The automatic answering feature is supported. The user/application can specify the number of rings after which the module will make an answer automatically.

3.12.12. Supplementary services

The following supplementary services are supported:

- Call Barring
- Call Forwarding
- Calling Line Identification Presentation (CLIP)
- Calling Line Identification Restriction (CLIR)
- Call Waiting, other party call Waiting Indication
- Call Hold, other party Hold/Retrieved Indication
- Closed User Group supplementary service (CUG)
- Advice of Charge
- Unstructured SS Mobile Originated (MO)

3.13. Mounting the modules on your board

The modules have been designed in order to be compliant with a standard lead-free SMT process. For detailed information about PCB pad design and conditions to use in SMT process, please refer to the respective Hardware User Guide.



3.14. Packing system

According to SMT process, for picking & placing movement requirements, UE910 family is packaged on trays. Each tray contains 20 pieces in size of 176 x 329.

The level of moisture sensibility of UE910 family is "3", according with standard IPC/JEDEC J-STD-020, take care of all the relative requirements for using this kind of components. Special care for handling is highly required.



4. Evaluation Kit

In order to assist the customer in the development of the application, Telit offers the EVK2 Evaluation Kit that can be ordered separately. The EVK2 has a SIM card holder, the RS 232 serial port level translator, a direct UART connection, audio and antenna connector.

The EVK2 provides a fully functional solution for a complete data or phone application. The standard serial RS232 9 pin connector placed on the Evaluation Kit allows the connection of the EVK2 system with a PC or other DTE.

The development of the applications utilizing the Telit UE910 family must present a proper design of all the interfaces towards and from the module (e.g. power supply, audio paths, level translators), otherwise a decrease in the performances will be introduced or, in the worst case, a wrong design can even lead to an operating failure of the module.

In order to assist the hardware designer in his project phase, the EVK2 board presents a family of different solutions, which will cover the most common design requirements on the market, and which can be easily integrated in the OEM design as building blocks or can be taken as starting points to develop a specific one.

For a detailed description of the Telit Evaluation Kit, please refer to the documentation provided with the respective Hardware User Guide and EVK2 User Manual.



5. AT Commands

The UE910 family can be driven via the serial and USB interface using the standard AT commands.

The modules are compliant with:

1. Hayes standard AT command set, in order to maintain the compatibility with existing S/W programs.
2. 3GPP TS 27.007 specific AT command and WCDMA/GPRS specific commands.
3. 3GPP TS 27.005 specific AT commands for SMS (Short Message Service) and CBS (Cell Broadcast Service)

Moreover, the modules support also Telit proprietary AT commands for special purposes.

For more information about the AT commands supported by the modules, please refer to the AT Commands Reference Guide.



6. Safety Recommendations

READ CAREFULLY

Be sure the use of this product is allowed in the country and in the environment required. The use of this product may be dangerous and has to be avoided in the following areas:

- Where it can interfere with other electronic devices in environments such as hospitals, airports, aircrafts, etc.
- Where there is risk of explosion such as gasoline stations, oil refineries, etc. It is responsibility of the user to enforce the country regulation and the specific environment regulation.

Do not disassemble the product; any mark of tampering will compromise the warranty validity. We recommend following the instructions of the hardware user guides for a correct wiring of the product. The product has to be supplied with a stabilized voltage source and the wiring has to be conforming to the security and fire prevention regulations. The product has to be handled with care, avoiding any contact with the pins because electrostatic discharges may damage the product itself. Same cautions have to be taken for the SIM, checking carefully the instruction for its use. Do not insert or remove the SIM when the product is in power saving mode. The system integrator is responsible of the functioning of the final product; therefore, care has to be taken to the external components of the module, as well as of any project or installation issue, because the risk of disturbing the WCDMA/GSM network or external devices or having impact on the security. Should there be any doubt, please refer to the technical documentation and the regulations in force. Every module has to be equipped with a proper antenna with specific characteristics. The antenna has to be installed with care in order to avoid any interference with other electronic devices and has to guarantee a minimum distance from the body (20 cm). In case of this requirement cannot be satisfied, the system integrator has to assess the final product against the SAR regulation.

The European Community provides some Directives for the electronic equipments introduced on the market. All the relevant information's are available on the European Community website:

<http://ec.europa.eu/enterprise/sectors/rtte/documents/>

The text of the Directive 99/05 regarding telecommunication equipments is available, while the applicable Directives (Low Voltage and EMC) are available at:

<http://ec.europa.eu/enterprise/sectors/electrical/>



7. Conformity assessment issues



EC DECLARATION OF CONFORMITY



1. **UE910-EUR** (product name)
2. Telit Communications S.p.A, Via Stazione di Prosecco, 5/b 34010 Sgonico –TRIESTE- ITALY (manufacturer)
3. This declaration of conformity is issued under the sole responsibility of the manufacturer
4. Dual Band 2G EGSM900 / DCS1800 and Dual Band 3G FDD I / FDD VIII Wireless Module



5. The object of the declaration described above is in conformity with the relevant Community harmonisation: European Directive 1999/05/EC (R&TTE)
6. The conformity with the essential requirements of the 1999/05/EC has been demonstrated against the following harmonized standards:

EN 301 511 V9.0.2 EN 301 908-1 V5.2.1 EN 301 908-2 V5.2.1	RF spectrum use (R&TTE art. 3.2)
EN 301 489-1 V1.9.2 EN 301 489-7 V1.3.1 EN 301 489-24 V1.5.1	EMC (R&TTE art. 3.1b)
EN 60950-1:2006 + A11:2009 + A1:2010 + A12:2011 + AC:2011 EN 62311:2008	Health & Safety (R&TTE art. 3.1a)
7. The conformity assessment procedure referred to in Article 10 and detailed in Annex IV of Directive 1999/5/EC has been followed with the involvement of the following Notified Body:
AT4 wireless, S.A., Parque Tecnológico de Andalucía, C/ Severo Ochoa 2, 29590 Campanillas – Málaga SPAIN, Notified Body No: 1909

Thus, **CE 1909** is placed on the product

8. The Technical Construction File (TCF) relevant to the product described above, and which supports this Declaration of Conformity, is held at: Telit Communications S.p.A Via Stazione di Prosecco, 5/b 34010 Sgonico (TRIESTE) ITALY

Signed for and on behalf of Telit Communications S.p.A

Trieste, **2013-06-26**

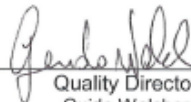
 Quality Director
Guido Walcher

 Cellular EMEA Manager
Antonino Sgroi

NBO number:	38138CNB.001A1
Technical Construction File:	UE910-EUX_38138_Rev_2

Mod 0211 2010-11 Rev.1- This declaration of conformity is issued in compliance with 768/2008/EC

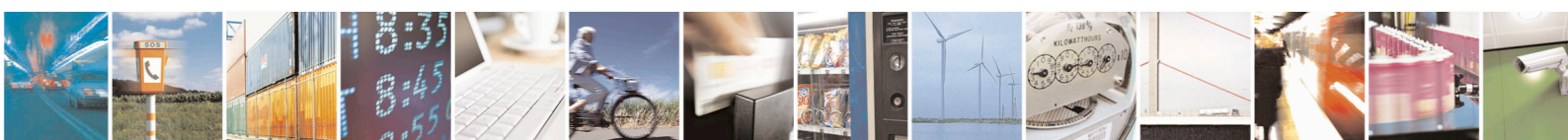



EC DECLARATION OF CONFORMITY



1. **UE910-EUD** (product name)
2. Telit Communications S.p.A, Via Stazione di Prosecco, 5/b 34010 Sgonico –TRIESTE- ITALY (manufacturer)
3. This declaration of conformity is issued under the sole responsibility of the manufacturer
4. Dual Band 2G EGSM900 / DCS1800 and Dual Band 3G FDD I / FDD VIII Wireless Module



5. The object of the declaration described above is in conformity with the relevant Community harmonisation: European Directive 1999/05/EC (R&TTE)
6. The conformity with the essential requirements of the 1999/05/EC has been demonstrated against the following harmonized standards:

EN 301 511 V9.0.2 EN 301 908-1 V5.2.1 EN 301 908-2 V5.2.1	RF spectrum use (R&TTE art. 3.2)
EN 301 489-1 V1.9.2 EN 301 489-7 V1.3.1 EN 301 489-24 V1.5.1	EMC (R&TTE art. 3.1b)
EN 60950-1:2006 + A11:2009 + A1:2010 + A12:2011 + AC:2011 EN 62311:2008	Health & Safety (R&TTE art. 3.1a)

7. The conformity assessment procedure referred to in Article 10 and detailed in Annex IV of Directive 1999/5/EC has been followed with the involvement of the following Notified Body:
AT4 wireless, S.A., Parque Tecnológico de Andalucía, C/ Severo Ochoa 2, 29590 Campanillas – Málaga SPAIN, Notified Body No: 1909

Thus, **CE 1909** is placed on the product

8. The Technical Construction File (TCF) relevant to the product described above, and which supports this Declaration of Conformity, is held at: Telit Communications S.p.A Via Stazione di Prosecco, 5/b 34010 Sgonico (TRIESTE) ITALY

Signed for and on behalf of Telit Communications S.p.A

Trieste, **2013-06-26**

Quality Director
Guido Walcher

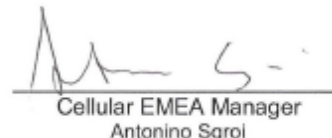
Cellular EMEA Manager
Antonino Sgrol

NBO number:	38138CNB.001A1
Technical Construction File:	UE910-EUX_38138_Rev_2

Mod 0211 2010-11 Rev.1- This declaration of conformity is issued in compliance with 768/2008/EC



7.2. FCC certificates

TCB

**GRANT OF EQUIPMENT
AUTHORIZATION**

TCB

**Certification
Issued Under the Authority of the
Federal Communications Commission**

By:

TUV SUD BABT
Forsyth House Churchfield Road
Walton-on-Thames, Surrey, KT12
2TD
United Kingdom

Date of Grant: 04/26/2013
Application Dated: 04/26/2013

Telit Communications S.p.A.
Viale Stazione di Prosecco 5/b
Trieste, 34010
Italy

Attention: Brian Tucker , Global VP, Quality

NOT TRANSFERABLE

EQUIPMENT AUTHORIZATION is hereby issued to the named GRANTEE, and is VALID ONLY for the equipment identified hereon for use under the Commission's Rules and Regulations listed below.

FCC IDENTIFIER: **RI7UE910NA**
Name of Grantee: **Telit Communications S.p.A.**
Equipment Class: **PCS Licensed Transmitter**
Notes: **2G/3G Module**
Modular Type: **Single Modular**

<u>Grant Notes</u>	<u>FCC Rule Parts</u>	<u>Frequency Range (MHZ)</u>	<u>Output Watts</u>	<u>Frequency Tolerance</u>	<u>Emission Designator</u>
	22H	824.2 - 848.8	1.91	2.5 PM	248KGXW
	22H	824.2 - 848.8	0.85	2.5 PM	248KG7W
	22H	826.4 - 846.6	0.66	2.5 PM	4M21F9W
	24E	1850.2 - 1909.8	0.85	2.5 PM	246KGXW
	24E	1850.2 - 1909.8	0.62	2.5 PM	247KG7W
	24E	1852.4 - 1907.6	0.47	2.5 PM	4M20F9W

Single Modular Approval. Power is conducted. The maximum antenna gain including cable loss for compliance with radiated power limits, RF exposure requirements and the categorical exclusion requirements of 2.1091 is 10 dBi for 850MHz bands and 9.31 dBi for 1900MHz bands. The antenna(s) used for this transmitter must be installed to provide a separation distance of at least 20cm from all persons and must not be co-located or operated in conjunction with any antenna or transmitter not described under this FCC id, except in accordance with FCC multi-transmitter product procedures.

The final product operating with this transmitter must include operating instructions and antenna installation instructions, for end-users and installers to satisfy RF exposure compliance requirements. Compliance of this device in all final product configurations is the responsibility of the Grantee. Installation of this device into specific final products may require the submission of a Class II permissive change application containing data pertinent to RF Exposure, spurious emissions, ERP/EIRP, and host/module authentication, or new application if appropriate.

This device contains GSM functions that are not operational in the U.S. Territories. This filing is only applicable for U.S. operations.



TCB

GRANT OF EQUIPMENT AUTHORIZATION

TCB

Certification
Issued Under the Authority of the
Federal Communications Commission
By:

TUV SUD BABT
Forsyth House Churchfield Road
Walton-on-Thames, Surrey, KT12
2TD
United Kingdom

Date of Grant: 04/26/2013
Application Dated: 04/26/2013

Telit Communications S.p.A.
Viale Stazione di Prosecco 5/b
Trieste, 34010
Italy

Attention: Brian Tucker , Global VP, Quality

NOT TRANSFERABLE

EQUIPMENT AUTHORIZATION is hereby issued to the named GRANTEE, and is VALID ONLY for the equipment identified hereon for use under the Commission's Rules and Regulations listed below.

FCC IDENTIFIER: RI7UE910NA
Name of Grantee: Telit Communications S.p.A.
Equipment Class: Part 15 Class B Computing Device Peripheral
Notes: 2G/3G Module
Modular Type: Single Modular

<u>Grant Notes</u>	<u>FCC Rule Parts</u>	<u>Frequency Range (MHZ)</u>	<u>Output Watts</u>	<u>Frequency Tolerance</u>	<u>Emission Designator</u>
	15B				

Single Modular Approval.

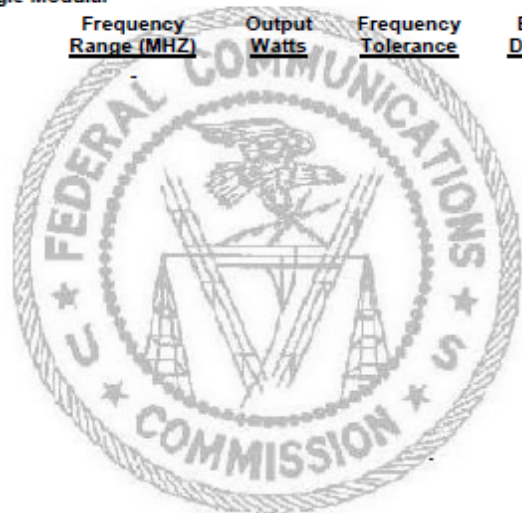

7.3. IC certificates

ZERTIFIKAT ◆ CERTIFICATE ◆ CERTIFICADO ◆ СЕРТИФИКАТ ◆ CERTIFICAT ◆ 認証証書



FCB Technical Acceptance Certificate

CB Number: UK00004

ISSUED TO CERTIFICATION No. DESCRIPTION TYPE OF EQUIPMENT LISTING TYPE MODEL(S) ANTENNA INFORMATION RF EVALUATION TYPE SPECIFICATION(S) MANUFACTURING No. REPRESENTATIVE No. IC OATS FACILITY No. IC OATS FACILITY	> Telit Communications S.p.A. Via Stazione Di Prosecco 5/B 34010 – Trieste Italy > 5131A- UE910NA > 2G/3G Module > Cellular Mobile GSM (824-849 MHz) PCS Mobile (1850-1910 MHz) Cellular Mobile New Technologies (824-849MHz) Modular Approval > Original Family > UE910-NAR; UE910-NAD > External > RF Evaluation > RSS-132 Issue 3 RSS-133 Issue 6 > 5131A > 5131B > 2324G-1 > Compliance Certification Services Inc. No.11, Wugong 6 th Rd, Wugu Dist, New Taipei City 24891, TAIWAN Tel: 886-2-2299-9720; Fax: 886-2-2298-4045 Email: service@ccsrf.com
--	---

Frequency Range (MHz)	Power Output (W)	Occupied Bandwidth (KHz)	Emission Designator
824.2 – 848.8	0.125	248	248KGXW
824.2 – 848.8	0.125	248	248KG7W
826.4 – 846.6	0.115	4210	4M21F9W
1850.2 – 1909.8	0.453	246	246KGXW
1850.2 – 1909.8	0.45	247	247KG7W
1852.4 – 1907.6	0.028	4200	4M20F9W

Authorised by:  Issue Date: 08 May 2013

Title of Signatory: Certification Manager Number: CD/000230 Issue: 2

I hereby attest that the subject equipment was tested and found in compliance with the above-noted specification
 J'atteste, par la présente, que le matériel a fait l'objet d'essai et a été jugé conforme à la spécification ci-dessus.

Certification of equipment means only that the equipment has met the requirements of the above noted specification. Licence applications, where applicable to use certified equipment, are acted on accordingly by the issuing office and will depend on the existing radio environment, service and location of operation. This certificate is issued on condition that the holder complies and will continue to comply with requirements and procedures issued by Industry Canada;
 La certification du matériel signifie seulement que le matériel a satisfait aux exigences de la norme indiquée ci-dessus. Les demandes de licences nécessaires pour l'utilisation du matériel certifié sont traitées en conséquence par le bureau de délivrance et dépendent des conditions radio ambiantes, du service et de l'emplacement d'exploitation. Le présent certificat est délivré à la condition que le titulaire satisfasse et continue de satisfaire aux exigences et aux procédures d'Industrie Canada;

Certified Equipment shall not be distributed, leased, sold or offered for sale in Canada before the details of the certification have been added to the REL. This certificate has been issued in accordance with the Certification Regulations of TÜV SÜD BABT. This certificate is not transferable and remains the property of TÜV SÜD BABT.

TÜV SÜD BABT • TÜV SÜD Group
 Octagon House • Concorde Way • Fareham • Hampshire • PO15 5RL • United Kingdom



